OWNER'S MANUAL SUPPLEMENT

ELECTRIC CHAIN HOIST ER and NER SERIES CYLINDER CONTROL MODEL

1/8 and 1/4 Ton Capacities

Code, Lot and Serial Number

⚠ WARNING

This equipment should not be installed, operated or maintained by any person who has not read and understood all the contents of this manual. Failure to read and comply with the contents of this manual can result in serious bodily injury or death, and/or property damage.

HARRINGTON
A KITO GROUP COMPANY

IMPORTANT INFORMATION ON HOW TO USE THIS MANUAL

This OWNER'S MANUAL SUPPLEMENT is intended for use *in combination* with the "Owner's Manual for Electric Chain Hoist ER and NER Series 1/8 through 5 Ton Capacity". Refer to the Table of Contents below to determine the location(s) of information pertaining to your hoist. References to the "Owner's Manual for Electric Chain Hoist ER and NER Series 1/8 through 5 Ton Capacity" will be designated by the use of the acronym "EROM".

Table of Contents

Section	Page Number
1.0 Important Information and Warnings	EROM
1.1 Terms and Summary	EROM
1.2 Warning Tags and Labels	EROM
2.0 Technical Information.....	4
2.1 Specifications	4
2.2 Dimensions	5
3.0 Preoperational Procedures	6 and EROM12
3.1 Fill Gear Box with Oil	EROM
3.2 Chain	6
3.3 Mounting Location	7
3.4 Mounting the Hoist	7
3.5 Electrical Connections	7
3.6 Preoperational Checks and Trial Operation	EROM
4.0 Operation	9 and EROM
4.1 Introduction	EROM
4.2 Shall's and Shall Not's for Operation	EROM
4.3 Hoist Controls	9

Section	Page Number
5.0 Inspection	EROM
5.1 General	EROM
5.2 Inspection Classification	EROM
5.3 Frequent Inspection	EROM
5.4 Periodic Inspection	EROM
5.5 Occasionally Used Hoists	EROM
5.6 Inspection Records	EROM
5.7 Inspection Methods and Criteria	EROM
6.0 Maintenance & Handling	EROM
6.1 Count/Hour Meter	EROM
6.2 Lubrication	EROM
6.3 Motor Brake	EROM
6.4 Load Chain	EROM
6.5 Friction Clutch and Mechanical Load Brake with Friction Clutch	EROM
6.6 Storage	EROM
6.7 Outdoor Installation	EROM
7.0 Troubleshooting	EROM
8.0 Material Safety Data Sheets	EROM
8.1 ER Model Gear Box Oil	EROM
8.2 NER Model Gear Box Oil	EROM
9.0 Warranty	EROM
10.0 Parts List	10 and EROM

2.0 Technical Information

2.1 Specifications

2.1.1 Product Code

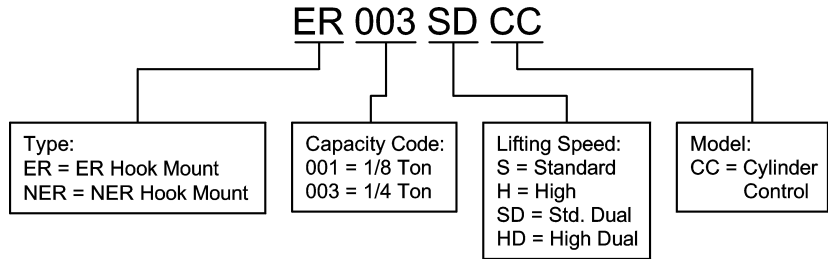

2.1.2 ER and NER Models - Harrington ER series hoist are available in two versions, the ER and NER. These two versions are equipped with different options as standard equipment. The NER has a friction clutch mechanism that provides over winding protection. The ER has a mechanical load brake/friction clutch combination and an electronic count/hour meter in the control circuit. Refer to Figure 2-1 for the visual differences between the ER and NER.

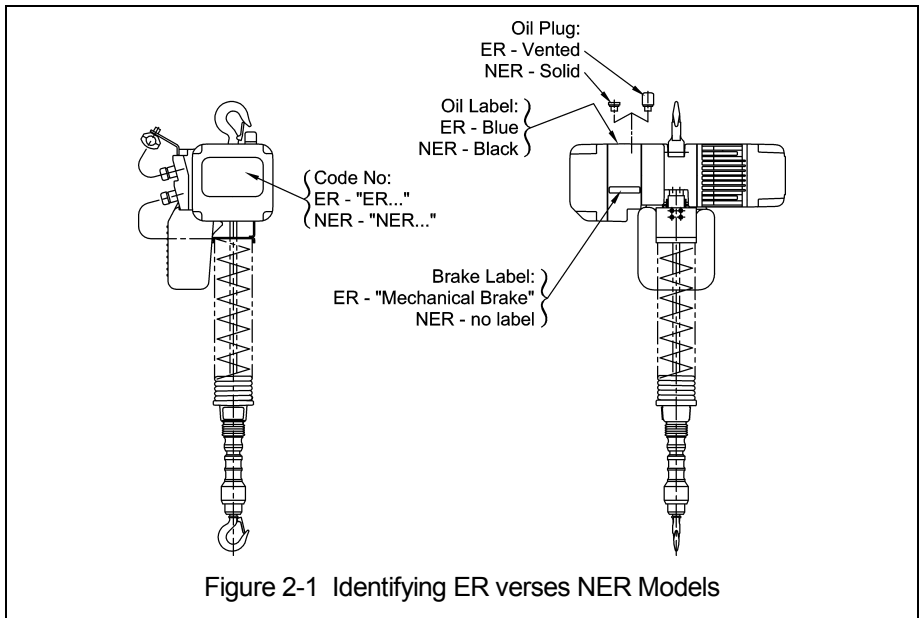

2.1.3 Operating Conditions and Environment

- Temperature range: -4° to +104°F (-20° to +40°C)
- Humidity: 85% or less
- Enclosure Rating: Hoist Meets IP 55, Cylinder Meets IP44
- Supply Voltage: Standard 208-230/460V-3-60, Optional 575V-3-60, Special Voltages Available

	Single Speed	Dual Speed
ASME Duty Classification:	H4	H4
Intermittent Duty Rating:	60% ED 360 starts per hour	40/20% ED 120/240 starts per hour
Short Time Duty Rating:	60 min.	30/10 min.

Table 2-1 Hoist Specifications										
Cap. (Tons)	Product Code	Standard Lift (ft)	Lifting Speed (ft/min)	Lifting Motor 3 Phase 60 Hz				Load Sheave Pockets	Load Chain Diameter (mm) X Chain Fall Lines	Net Weight (lbs)
				Output (Hp)	Rated Current (amps)					
					@208V - 230V	@460V				
Single Speed	1/8 ER001HCC	6	57	0.75	4.2	2.1	5	5.0 x 1	68	
	1/4 ER003SCC	6	39	0.75	4.2	2.1	5	5.0 x 1	68	
Dual Speed	1/8 ER001HDCC	6	58/19	0.6/0.2	2.9/2.4	1.5/1.2	5	5.0 X 1	79	
	1/4 ER003SDCC	6	29/10	0.6/0.2	2.9/2.4	1.5/1.2	5	5.0 X 1	79	

2.2 Dimensions

Table 2-2 Hoist Dimensions												
Cap. (Tons)	Product Code	Headroom C	D (in)	a (in)	b (in)	d (in)	e (in)	f (in)	g (in)	h (in)	i (in)	
Single Speed	1/8 ER001HCC	40.6	17.7	21.1	13.0	10.4	10.7	10.4	1.0	4.0	3.9	
	1/4 ER003SCC	40.6	17.7	21.1	13.0	10.4	10.7	10.4	1.0	4.0	3.9	
Dual Speed	1/8 ER001HDCC	40.6	17.7	22.2	13.0	10.4	11.9	10.4	1.0	4.0	3.9	
	1/4 ER003SDCC	40.6	17.7	22.2	13.0	10.4	11.9	10.4	1.0	4.0	3.9	

Table 2-3 Hook Dimensions								
	Capacity Code	Hook**	a (in)	b (in)	c (in)	d (in)	e (in)	g (in)
	001H, 003S	T	1.1	0.7	0.9	0.7	1.4	1.1
		B	0.8	0.5	0.7	0.5	1.4	1.0

3.0 Preoperational Procedures

3.2 Chain

- 3.2.1 Chain Components – Refer Figure 3-1 and ensure that stoppers and cushion rubbers are in the correct location and properly installed. Never operate the hoist with incorrect, missing or damaged chain components.

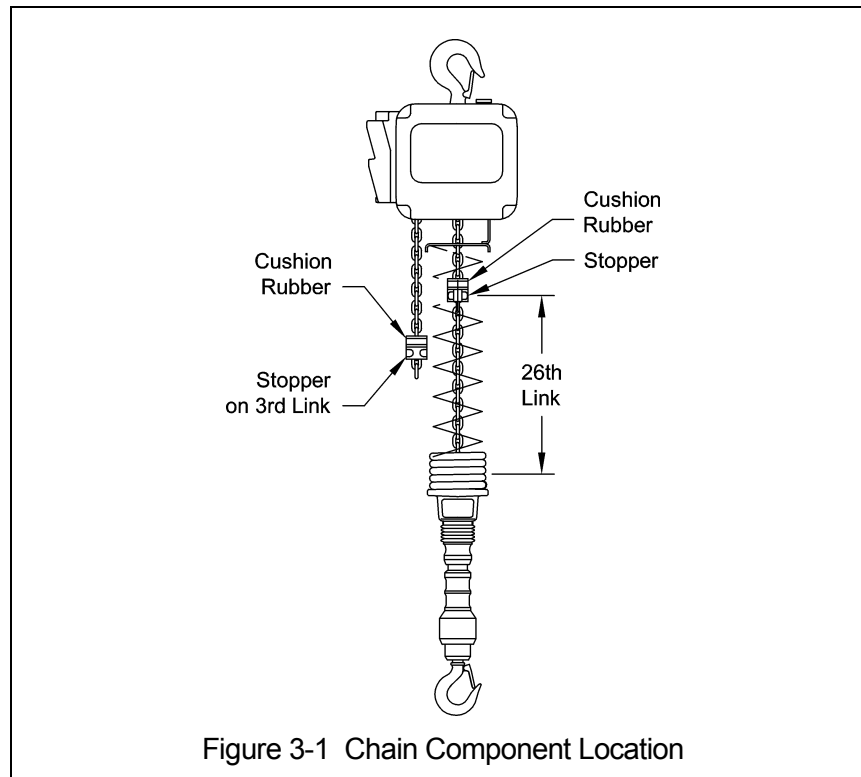

- 3.2.2 Chain Container – Install the chain container on the hoist body as shown in Figure 3-2. To place the chain into the chain container, feed the chain into the chain container beginning with the free end. Take care to avoid twisting or tangling the chain. NEVER put all the chain into the container at once. Lumped or twisted chain may jam against the hoist body activating the friction clutch and potentially damaging the chain.

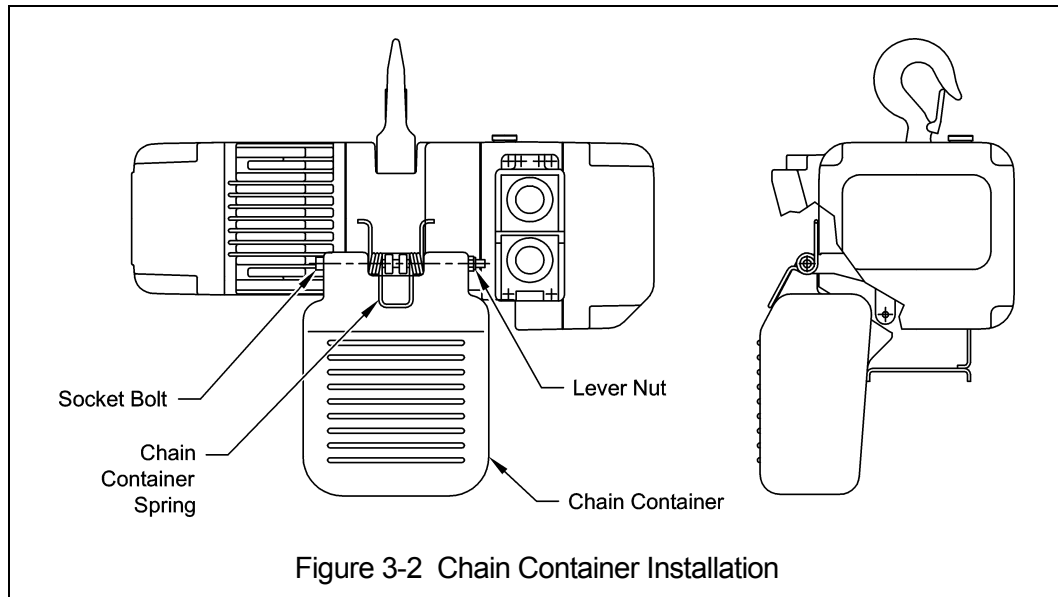

3.3 Mounting Location

3.3.1 **⚠ WARNING** Prior to mounting the hoist ensure that the suspension and its supporting structure are adequate to support the hoist and its loads. If necessary consult a professional that is qualified to evaluate the adequacy of the suspension location and its supporting structure.

3.3.2 **NOTICE** See Section 6.7 of the **EROM** for outdoor installation considerations.

3.4 Mounting the Hoist

3.4.1 Manual Trolley - Follow instructions in Owner's Manual provided with the trolley.

3.4.2 Motorized Trolley – Cylinder control model hoists are NOT intended to be used with motorized trolleys.

3.4.3 Hook Mounted to a Fixed Location - Attach the hoist's top hook to the fixed suspension point.

3.4.4 **⚠ CAUTION** Mount the hoist at a height that will allow the operator to maintain a clearance of at least 4 inches between the Cushion Rubber and the hoist body during operation.

3.4.5 **⚠ WARNING** Ensure that the fixed suspension point rests on the center of the hook's saddle and that the hook's latch is engaged.

3.5 Electrical Connections

3.5.1 **⚠ CAUTION** Ensure that the voltage of the electric power supply is proper for the hoist.

3.5.2 **⚠ DANGER** Before proceeding, ensure that the electrical supply for the hoist has been de-energized (disconnected). Lock out and tag out in accordance with ANSI Z244.1 "Personnel Protection -Lockout/Tagout of Energy Sources".

3.5.3 Coiled Control Cable - The Coiled Control Cable connects to the hoist via a 5-pin (5P) or 8-pin (8P) Plug and Socket. Make this connection as follows:

- Refer to Figure 3-3.
- Insert the 5P/8P Plug into the 5P/8P Socket on the hoist and hand tighten the Screw Coupling.

- 3.5.4 Power Supply Cable Hoist Connection – The Power Supply Cable connects to the hoist via a 4-pin (4P) plug and socket. Make this connection as follows:
- Refer to Figure 3-3.
 - Insert the 4P plug of the Power Supply Cable into the 4P Socket on the hoist and hand tighten the screw coupling.
 - Install the Cable Support Arm (pre-installed on the Power Supply Cable) on to the Socket Holder using the pre-installed Machine Screws and Lock Washers.
Use care to avoid twisting or kinking the Power Supply Cable.

- 3.5.5 Power Supply Cable Installation – If the hoist is hook mounted to a fixed support ensure that the Power Supply Cable is properly installed and supported between the hoist and the electrical power supply.

If the hoist is installed on a manual trolley, then the Power Supply Cable must be installed along the beam that the trolley runs on. For curved beams a special cable suspension system will be needed, and this instruction does not apply. For straight beams install the Power Supply Cable as follows:

- Install a guide wire system parallel to the beam.
- For a manual trolley the guide wire should be positioned slightly outside the hoist's Cable Support as shown in Figure 3-3.
- Use the Cable Trolleys supplied with the hoist to suspend the Power Supply Cable from the guide wire. Space the Cable Trolleys every 5 feet.

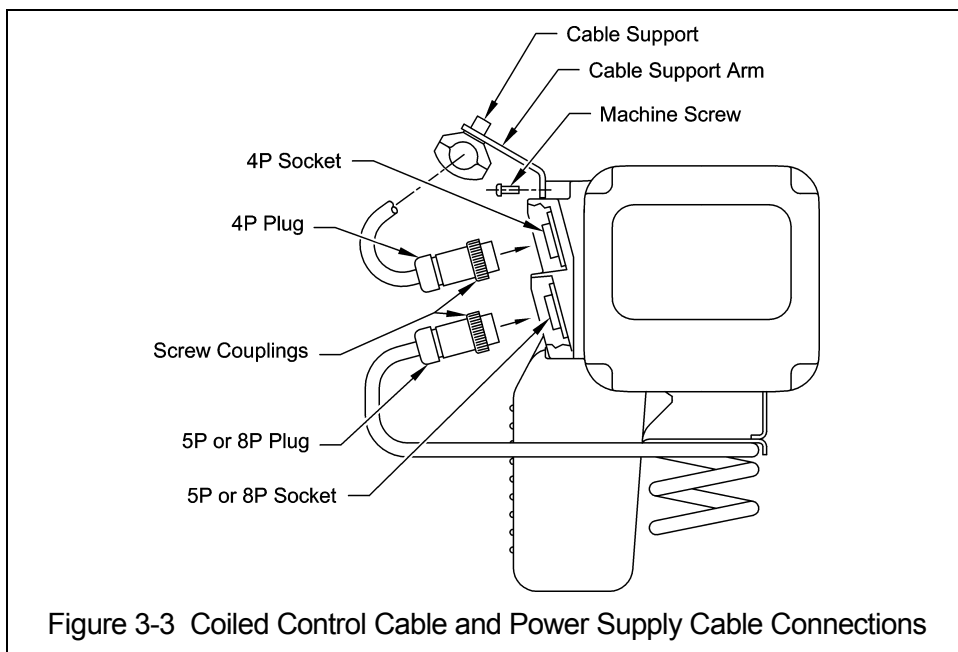

- 3.5.6 Connection to Electrical Power Source - The red, white, and black wires of the Power Supply Cable should be connected to an Electric Power Disconnect Switch or Circuit Breaker. This connection should be made so that the hoist is phased properly. Refer to Section 3.6.11 of the EROM for instructions on how to check for correct power supply phase connection.
- 3.5.7 Fuse/Breaker Capacity -The hoist's power supply should be equipped with overcurrent protection such as fuses, which should be selected for 110% to 120% of total listed full load amperage, and should be dual element time-delay fuses. Refer to the motor nameplate for the full load amperage draw.
- 3.5.8 **⚠ DANGER** Grounding - An improper or insufficient ground connection creates an electrical shock hazard when touching any part of the hoist or trolley. In the Power Supply Cable the ground wire will be either Green with Yellow stripe or solid Green. It should always be connected to a suitable ground connection. Do not paint the trolley wheel running surfaces of the beam as this can affect grounding.

4.0 Operation

4.3 Hoist Controls

- 4.3.1 Single Speed Hoists – Firmly hold the black Grip on the cylinder control. Slide the Up/Down Switch Operator up to raise the load or down to lower the load as shown in Figure 4-1. To stop the hoist slide the Up/Down Switch Operator back to the middle position.
- 4.3.2 Dual Speed Hoists – Select high or low speed using the Speed Selector Switch. Lights adjacent to the Speed Selector Switch indicate if low or high speed is selected. Slide the Up/Down Switch Operator up to raise the load or down to lower the load Figure 4-1. To stop the hoist slide the Up/Down Switch Operator back to the middle position.
- 4.3.3 **CAUTION** Make sure the motor completely stops before reversing direction.

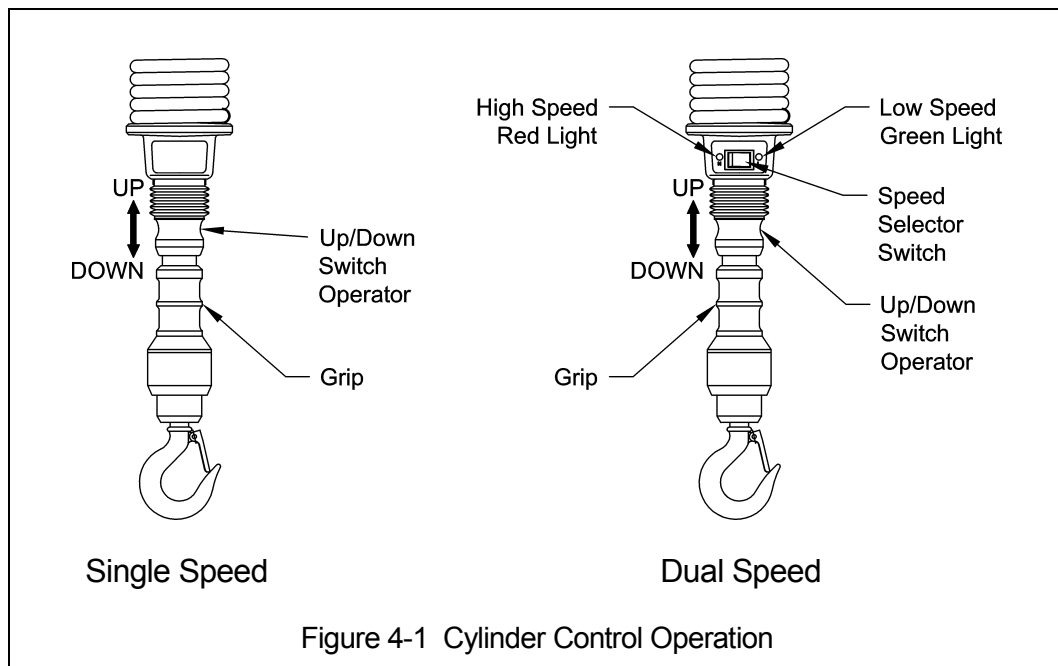

10.0 Parts List

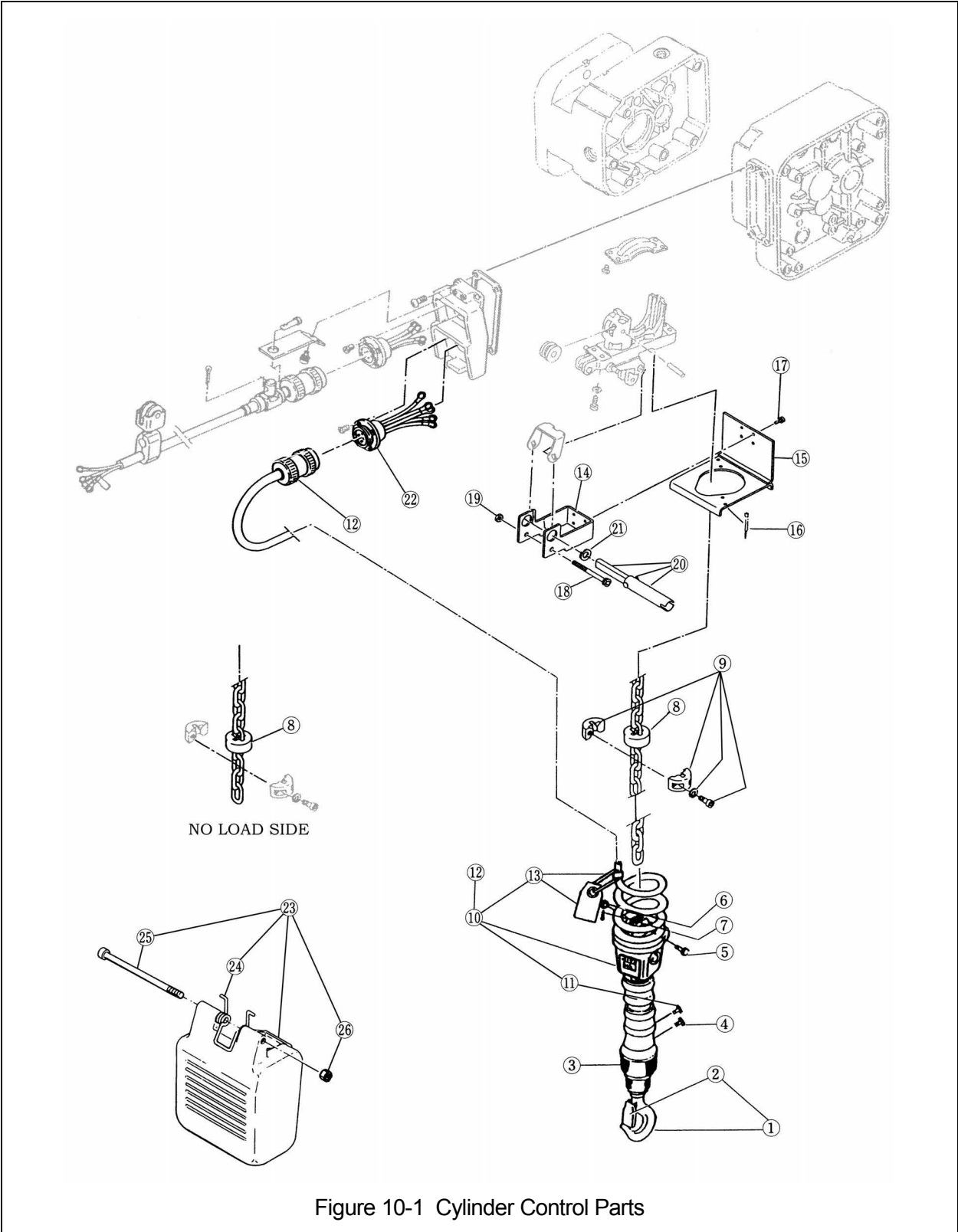

Figure 10-1 Cylinder Control Parts

Figure No.	Part Name	Parts per Hoist	Part Number
1	Detachable Hook Assy	1	CD1BI1011
2	Latch Assembly	1	CF071005
3	Detachable Fitting E	1	E2D5041125
4	Flat Head Screw	1	9096528
5	Chain Pin	1	M3041005
6	Slotted Nut	1	M3049005
7	Split Pin	1	9009402
8	Cushion Rubber	2	E5FE003S9046
9	Stopper Assembly	2	ES1045003
10	Cylinder Switch Set	S	1 C10013H1020
		D	1 C20013H1020
11	Truss-Head Screw	1	TRUSSM4X10
12	5P Plug	S	1 ES613003
	8P Plug	D	1 ESM538010
13	Warning Tag	1	WTAG7
14	Cable Holder A	1	CD1BS9750
15	Cable Holder B	1	CD1BS9751
16	Cable Tie	2	9006602
17	Machine Screw w/Spring Washer	4	MS554010
18	Socket Bolt	1	9091259
19	Lever Nut	1	ES855003
20	Limit Lever Pin Assembly	1	CD1BS2757
21	Spacer	1	CD1BS9758
22	5P Socket	S	1 CD1BS1564
	8P Socket	D	1 CD1BB1564
23	Chain Container Kit	1	PBK-B
24	Chain Container Spring	1	ER1BS9416
25	Socket Bolt	1	J1BE10816513
26	Lever Nut	1	ES857005S



Harrington Hoists, Inc.
401 West End Avenue
Manheim, PA 17545

www.harringtonhoists.com

Toll Free: 800-233-3010
Phone: 717-665-2000
Fax: 717-665-2861

ERCYLSUP-ENG