

SHB Ultra-Low Headroom Trolley Hoist

Harrington's SHB ultra-low trolley hoist offers premium quality and durability in a low profile package. This industrial grade hand chain hoist and geared trolley configuration minimizes beam-to-hook distance making it ideal for applications where longer hook travel is required.

Many Benefits from More Features:

- Extremely low headroom for use where space is limited.
- Efficient hoist drive train minimizes effort required to operate.
- Trolley wheels fit on both tapered and flat flanged beams.
- Maintenance-free sealed trolley ball bearings are lubed-for-life and offer smooth movement with low friction and long life.

Capabilities to Count On:

- 20-foot lift is standard. Nonstandard lifts and hand chain drops are also available.
- All-steel construction for hoist durability.
- Reliable hoist braking with double enclosed brake cover that keeps out rain, dust and dirt.
- Grade 100 heat-treated manganese alloy load chain resists abrasion and wear.
- Cast trolley wheels and steel side plates for heavy-duty applications.



SHB ULTRA-LOW HEADROOM TROLLEY HOIST — DIMENSIONS

Cap. (Tons)	Product Code	b1 (in)	b2 (in)	d (ft)	e1 (in)	e2 (in)	f (ft)	g (in)	h (in)	i (in)	j (in)	k (in)	m (in)	n1 (in)	n2 (in)	q (in)	r (in)	s (in)	t (in)	u (in)	v (in)
1	SHB010	8.0	13.5	19.3	7.9	7.0	19.3	1.1	4.17	2.80	1.0	4.5	8.7	5.9	11.4	14.6	1.8	B-1.6	1.22	6.02	9.6
2	SHB020	9.6	15.7	19.0	8.9	7.6	19.0	1.4	5.00	3.35	1.2	6.6	9.9	7.1	13.2	17.3	2.1	B-2.0	1.42		11.4
3	SHB030	11.6	18.3		9.5	8.1		1.7	5.83	3.94	1.3	7.0	10.6	8.7	15.4	18.3	2.4	B-2.2	1.73	7.20	12.8
5	SHB050	13.8	21.3	10.5	8.8	1.8	6.65	4.65	1.4	8.8	11.9	10.4	17.9	19.5	2.8	B-2.9	2.17	15.4			
8	SHB080	15.5	23.1	11.4	8.5	19.0	19.0	2.4	7.29	6.10	1.3	10.5	13.2	11.8	19.4	19.6	3.3	B-3.5	2.76	8.43	16.5
10	SHB100																				

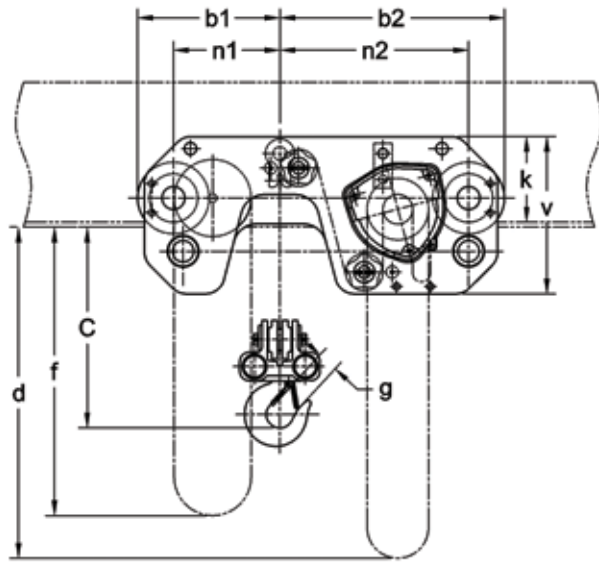
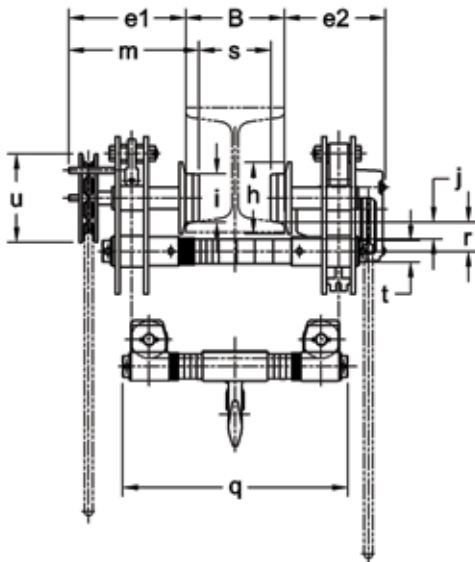

SHB

SHB ULTRA-LOW HEADROOM TROLLEY HOIST — SPECIFICATIONS

Cap. (Tons)	Product Code	Headroom C (in)	Standard Lift (ft)	Pull to Lift Load (lbs)	Overhaul Ratio	Flange Width Adjustability B (in)	Load Chain Dia. (mm) x Chain Fall Lines	Net Weight Approx. (lbs)	Shipping Weight Approx. (lbs)	Weight for Additional One Foot of Lift (lbs)
						Standard*				
1	SHB010	4.5	20	59	50	2.28 to 6.42	5.0 x 2	166	176	2.0
2	SHB020	5.7		54	114	3.23 to 8.03	7.1 x 2	271	281	2.8
3	SHB030	6.5		63	140		8.0 x 2	385	395	3.1
5	SHB050	7.7		75	198	3.94 to 8.03	9.0 x 2	655	665	3.7
8	SHB080	10.0		65	396	5.50 to 8.66	9.0 x 4	858	868	6.1
10	SHB100		81							

Due to wheelbase length, the SHB can not negotiate a curved beam.
 *Other beam widths available. Consult Customer Service.